

● **DESCRIPTION:**

The holding electromagnets (electromagnetic and electropermanent) are used to attract and hold ferromagnetic pieces.
 The maximum force efficiency is achieved with the piece to be hold over the attraction's face and in direct contact with both poles (outside pole and inside pole).

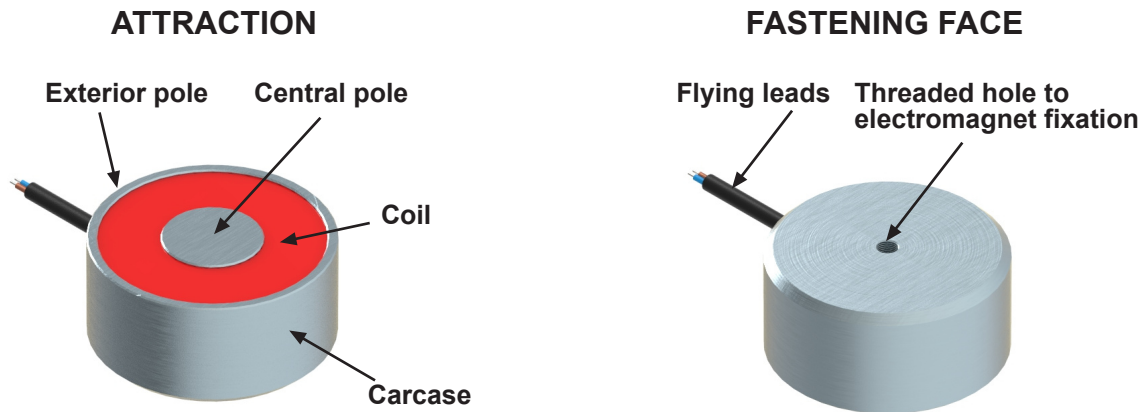

It is not recommended to use holding electromagnets in applications that require an air gap > 0.2mm. The retention force will fall down exponentially when the air gap increases (as can be seen in the data sheet of each product).

● **CONDITIONS FOR A CORRECT INSTALATION, USE AND MAINTENANCE:**

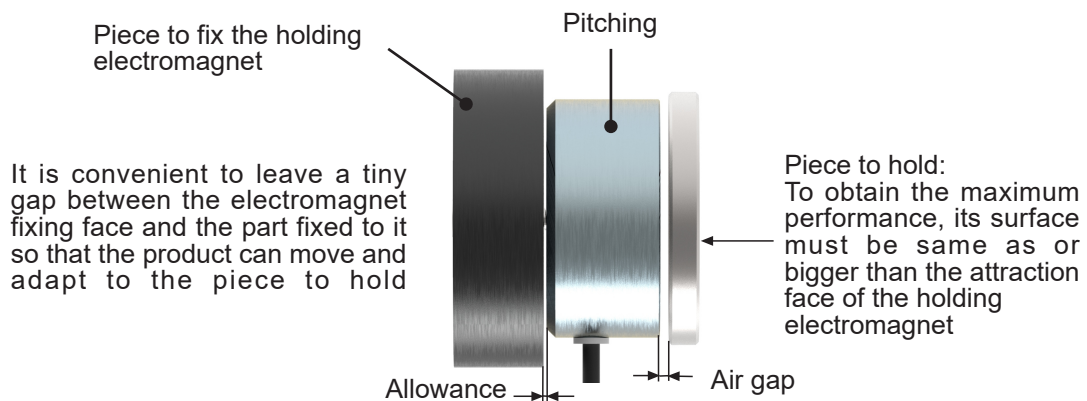

In electropermanent holding electromagnets, vibration and temperature higher than the one recommended must be avoided because it could damage the magnet and the product would loose force.

● **MAINTENANCE:**

If the attraction face suffers bumps when working, a reduction of force will occur due to the air gap generated by them, and to recover the initial force, attraction face must be rectified.

● CUSTOMIZATION

The models described in the catalogue are standard and minimum manufacturing batches are not required. However, there is the possibility of customizing them to suit better customer's needs. See below some of the most common customizations.

If any modification is needed, please ask NAFSA about the possibility and the minimum manufacturing batch required.

1. ELECTRICAL CUSTOMIZATION

a) Integrated electronics only in versions with DIN43650A connector:

a.1) For peak suppression Examples:

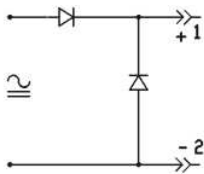

Free wheel diode+second diode to protect the free wheel diode against reverse polarity.

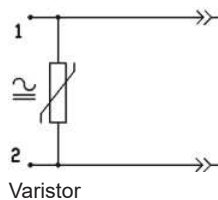

a.2) Power display Examples:

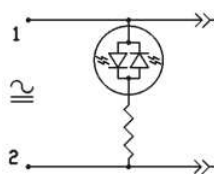

Connector under voltage display by LED

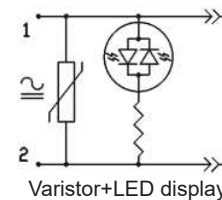

a.3) For rectification Examples:

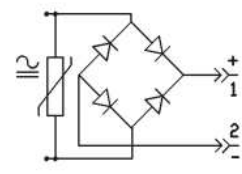

4 diodes with varistor at the input

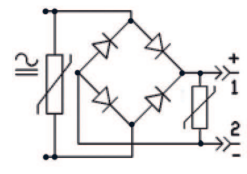

4 diodes with double varistor.

b) Cable length modification and terminal or connector mounted over cables:

In some holding electromagnet models, cables can be replaced by connector DIN43650 or clamping screw (see each serie datasheet). In the holding electromagnet models which have supply cables, this length can be modified to customer requirement. Likewise any kind of terminals or connectors can be added to the cables.

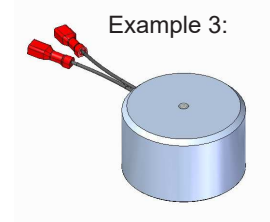
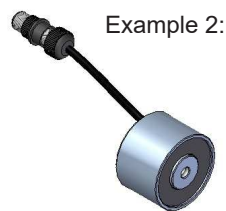
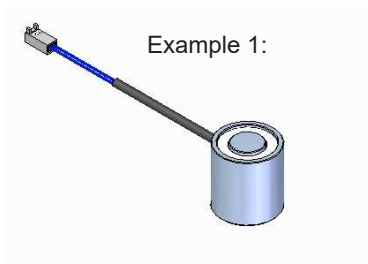

c) Intermediate duty-cycle manufacturing:

In the VEM and ERM are manufactured by default with duty-cycle is 100%, but NAFSA can manufacture any intermediate duty-cycle from 0 to 100, but the viability depends on the model and the voltage associated with it. For any special requirement, please ask NAFSA.

In the VM and VM/ND series the duty-cycle can not be modified.

2. INSULATION CLASS CUSTOMIZATION:

In the VEM serie, insulation class can be increased until H (180°C).

In the VM and VM/ND, insulation class can be increased until F (155°C).

3. PROTECCIÓN RATE CUSTOMIZATION IP (EN60529):

Standard models are IP65, but it can be decreased until IP40 to cheapen production cost.

NOTE: All this customizations cannot be applied to all models, ask NAFSA for each case.

• CUSTOMIZATION

The models described in the catalogue are standard and minimum manufacturing batches are not required. However, there is the possibility of customizing them to suit better customer's needs. See below some of the most common customizations.

If any modification is needed, please ask NAFSA about the possibility and the minimum manufacturing batch required.

4. MECHANICAL CUSTOMIZATION:

The viability of the modifications depends on the model. For any special requirement, ask NAFSA.

4.1) Fastening holes modification:

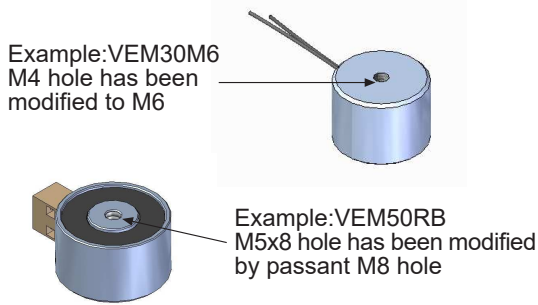

4.2) Non-rotating holes integration:

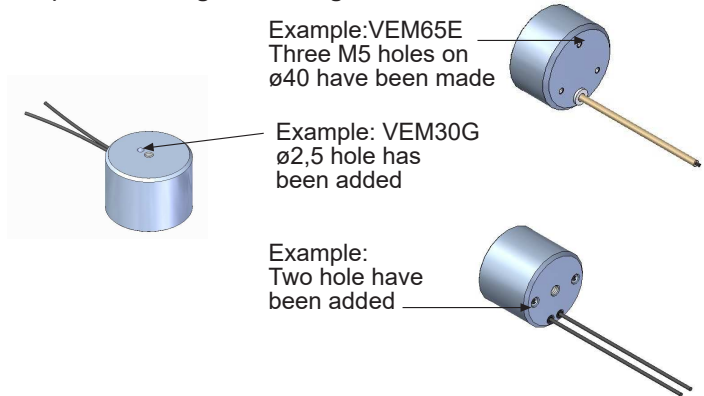

4.3) Cable or connector position modification:

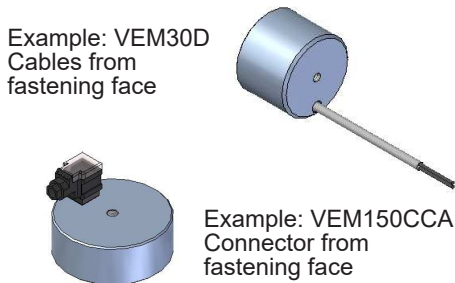

4.4) Carcase shape modification:

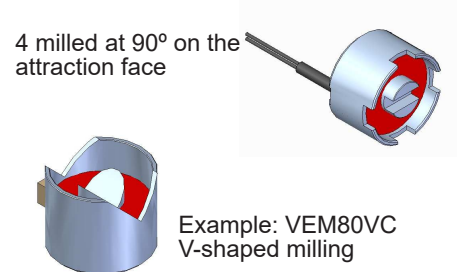

4.5) Antiremanence pins:



4.6) Holding plate fabrication:



4.7) Position detection system:

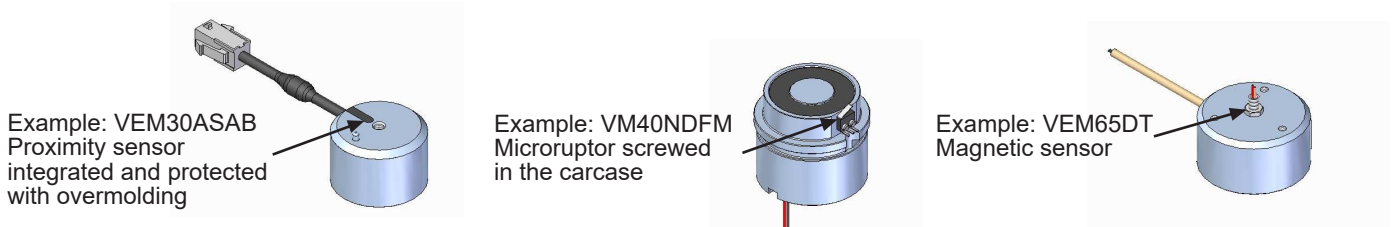

NOTE: All this customizations cannot be applied to all models, ask NAFSA for each case.

• VEM SERIE

The attraction and holding of the magnetic pieces are obtained feeding the winding inside the solenoid. When the power supply stops the electromagnet loses the piece.
When working with loads security norms must be respected.

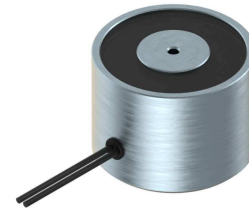

Protection rate: **IP65**
Insulation class: **B (130°C)**
Standard voltage: **24 VDC**
Standard duty cycle: **ED100%**
Other voltages, ED and sizes: **Consult**

Flying leads for every size.
Supply possibilities under demand:
*With **clamping screw** from the VEM25
*With **connector** from the VEM65.
The connector (1) has 4 possibilities of direction (4x90°) and it is possible to be incorporated to the same diodes of rectification for alternating current connection (AC).

Table 1

TYPE	øA (-0,3)	B	C±0.1	D	E	F	Weight (Kg)
VEM 20	20	M-3	12	5	---	---	0.02
VEM 25	25	M-4	20	6	---	40	0.06
VEM 30	30	M-4	22	6	---	45	0.10
VEM 40	40	M-5	26	8	---	55	0.20
VEM 50	50	M-5	30	8	---	65	0.30
VEM 65	65	M-8	35	12	112	80	0.80
VEM 80	80	M-8	38	12	127	95	1.30
VEM 100	100	M-10	43	15	147	115	2.10
VEM 150	150	M-16	56	24	197	165	6.40

Flying leads: Ref: VEM (type)-V - ED%
Example: VEM 65-24Vdc- ED100%

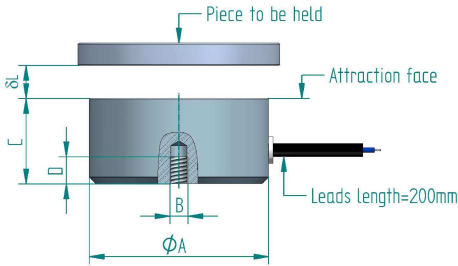

Connector (C): Ref: VEM (type)/C-V-ED%
Example: VEM65/C-24Vdc ED100%
Connection:
see documentation that is enclosed with the material

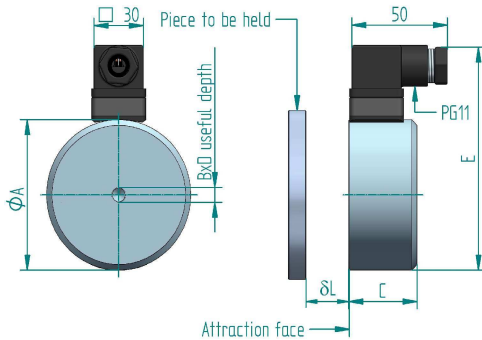

Clamping screw (B): Ref: VEM(type)/B-V-ED%
Example: VEM50/B-24Vdc-ED100%

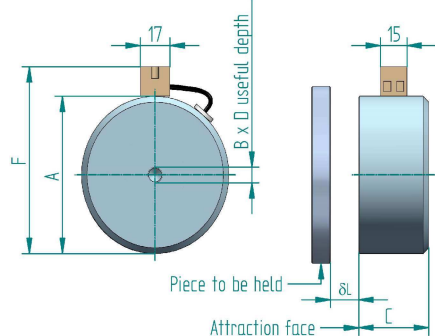

Important: the clamping screw does not have to exceed measure D

Table 2

TYPE	P at 20°C (W)	e (mm)	Air gap (mm) δ_L					Magnetic Force Fm (N)
			0	0,1	0,2	0,5	1	
VEM20	1.6	1	14.5	3.8	1.6	0.3		
		3	27	5.7	2.6	0.35		
VEM25	3.2	1	27	19	12	3		
		3	114	47	20	3.5		
		6	135	50	21	3.7		
VEM30	4	1	37	24	18	6	1.5	
		3	170	80	40	9.5	1.6	
		6	190	90	45	12	2	
VEM40	5.6	1	38	30	24	13	4	
		3	300	203	133	27	4.5	
		6	400	245	160	30	5	
VEM50	6.5	1	40	32	30	20	15	
		3	320	235	185	65	16	
		6	500	370	240	68	20	
VEM65	10	1	45	40	35	25	15	
		3	310	290	250	148	40	
		6	830	660	500	164	46	
		10	980	750	560	190	50	
VEM80	15	1	65	42	40	30	20	
		3	430	360	325	230	90	
		6	1150	970	830	375	110	
		10	2000	1350	1000	420	125	
VEM100	20	1	70	50	45	35	25	
		3	530	440	426	335	225	
		6	1400	1200	1050	730	310	
		10	2600	2200	1700	880	330	
VEM150	40	3	700	580	550	480	390	
		6	1810	1650	1580	1400	1100	
		10	5800	4350	3910	3000	1850	
		18	7104	5760	4992	3840	2400	

e (mm): Thickness of the piece to hold

The table 2 gives for each type of holding magnet, the values of the force of maintenance (Fm) based on the air gap, measured in the following conditions:

- Direct current supply.
- Flat piece (3 μ m rugosity) in A°St37, thickness as shown in the table 2 and dimensions are similar or bigger than the attraction face.
- Room temperature 35°C.
- Coil working on its regime temperature.

At different conditions, the magnetic force (Fm) may decrease. The value of the magnetic remanence after the power supply stops is 5% of the holding force.

- *Earthing is recommended if the metallic parts are accessible.
- *Technical explanation: see pages 4 & 5.
- *Under demand: any size, voltage, duty cycle etc can be manufactured.



When lifting or handling heavy loads a minimum security margin of 3 must be respected, the weight of the load cannot exceed 33% of the magnetic force.

ERM SERIE

The attraction and holding of the magnetic pieces are obtained by feeding the winding inside the solenoid. When the power supply stops, the solenoid loses the piece.

When working with loads, security norms must be respected.

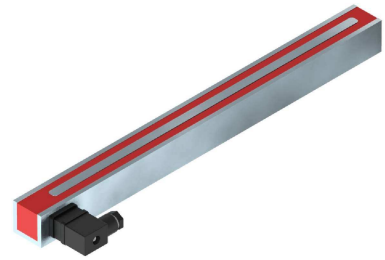

Protection rate: **IP65**
 Insulation class: **B (130°C)**
 Nominal Voltage: **24VDC**
 Standard duty cycle: **ED100%**
 Other voltages, ED and sizes: **Consult**

Table 1

TYPE	A	B	C	D	E	F	H	N° of holes	Compression gland	Weight(kg)
ERM100/35	125					10		2		0.9
ERM150/35	175					10		3		1
ERM200/35	225					10		4		1.5
ERM400/35	425	35±0.3	34±0.1	25	50	12	M-6	8	PG-9	2.8
ERM500/35	525					12		10		3.5
ERM600/35	625					12		12		4.5
ERM150/60	180			40	70			2		2.3
ERM200/60	230	60±0.1	49.5±0.2	40	120	12	M-8	2	PG-11	3
ERM500/60	530			70	120			4		7.8

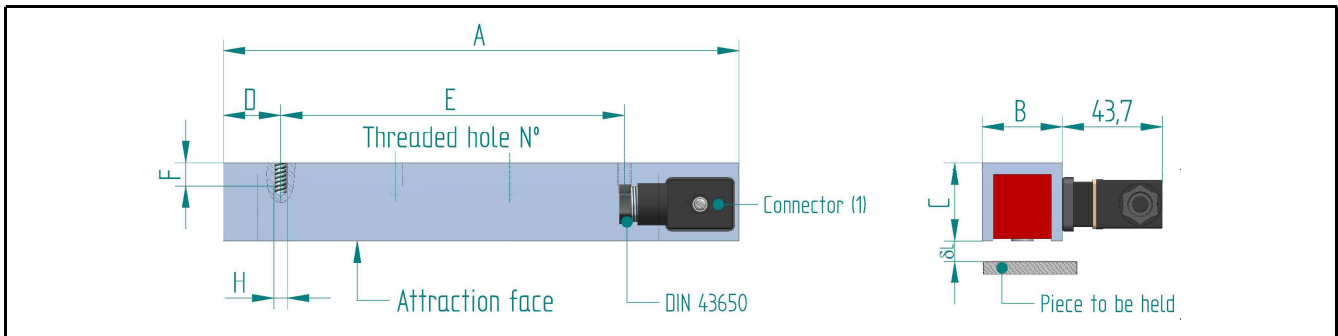

Table 2

TYPE	P at 20°C (W)	e (mm)	Airgap (mm)					Magnetic force Fm (N)
			0	0,1	0,2	0,5	1	
ERM100/35	10	1	32	22	12	8	6	
		3	396	308	120	45	8	
		6	604	320	190	52	12	
ERM150/35	14	1	65	50	30	21	14	
		3	769	580	220	82	17	
		6	1090	657	368	90	21	
ERM200/35	18	1	80	60	42	28	14	
		3	928	720	260	94	20	
		6	1400	810	460	121	27	
ERM400/35	30	1	172	131	91	60	35	
		3	2100	1460	537	210	45	
		6	3060	1722	962	263	60	
ERM500/35	45	1	210	150	100	60	36	
		3	2323	1806	674	234	56	
		6	3540	2100	1114	295	70	
ERM600/35	53	1	226	173	90	66	40	
		3	2653	2053	706	266	66	
		6	4053	2266	1286	346	80	
ERM150/60	25	1	140	112	102	75	50	
		3	780	680	600	445	180	
		6	1800	1490	1100	610	200	
ERM200/60	40	1	205	165	155	116	72	
		3	1130	990	890	680	250	
		6	2550	2160	1800	884	280	
ERM500/60	75	1	553	440	397	310	190	
		3	3150	2630	2320	1800	780	
		6	7250	5870	4650	2380	850	
		10	7450	5950	4820	2410	910	

The table 2 gives for each type of holding magnet, the values of the force of maintenance (Fm) based on the air gap, measured in the following conditions:
 -Direct current supply.
 -Flat piece (3µm rugosity) in A°St37, thickness as shown in the table 2 and dimensions are similar or bigger than the attraction face.
 -Room temperature 35°C.
 -Coil working on its regime temperature.
 At different conditions, the magnetic force(Fm) may decrease. The value of the magnetic remanence after the power supply stops is 5% of the holding force.

- Alternating current connection (AC):
 Only for sizes ERM150/60 to ERM500/60.
 - Earthing is recommended if the metallic parts are accessible.
 - Mounting, supply possibilities and ordering code: page 104.
 - Technical explanations: see pages 4 & 5.
 - Under demand: any size, voltage, duty cycle etc can be manufactured.

Ordering code: Size--V ED---%
 Voltage: 24Vdc; Duty cycle: ED100%
 ERM150/35 24Vdc 100%
 For other configurations see page 104

e= Thickness of the piece to hold

⚠ When lifting or handling heavy loads a minimum security margin of 3 must be respected, the weight of the load cannot exceed 33% of the magnetic force.

• **ERM SERIE**

Mounting and supply possibilities for rectangular holding electromagnet

• **ERM --/35**

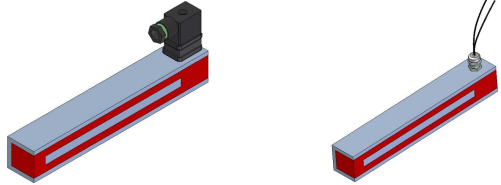
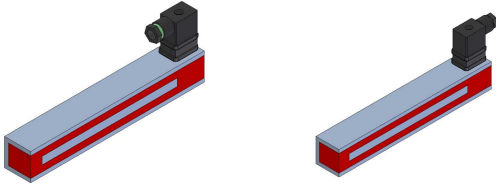
<p>Supply possibilities</p>  <p>A) Connector (Standard) B) Stuffing box (under demand)</p>	<p>2x180° connector</p>  <p>Standard mounting Opcional mounting under demand</p>
---	--

Connector and stuffing box different positions

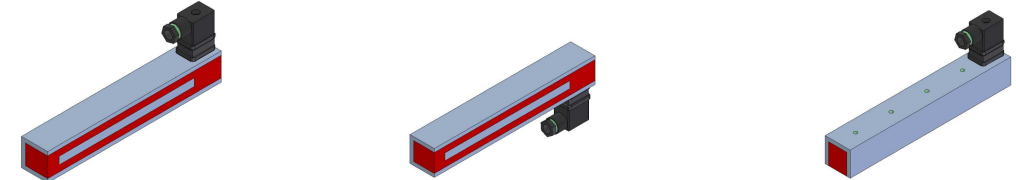

1) Standard mounting 2) Face opposite to standard mounting (Under demand) 3) Fastening face (Under demand)

• **ERM --/60**

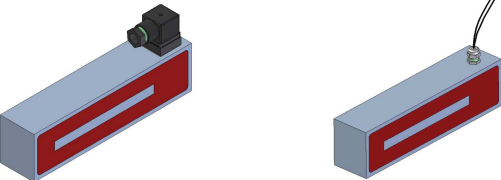
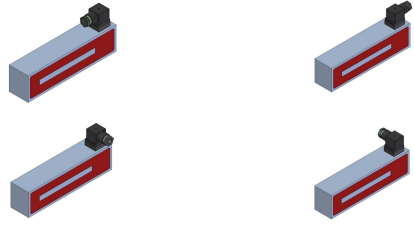
<p>Supply possibilities</p>  <p>A) Connector (Standard) B) Stuffing box (Under demand)</p>	<p>4x90° connector</p>  <p>Optional mounting under demand</p>
---	--

Connector and stuffing box different positions

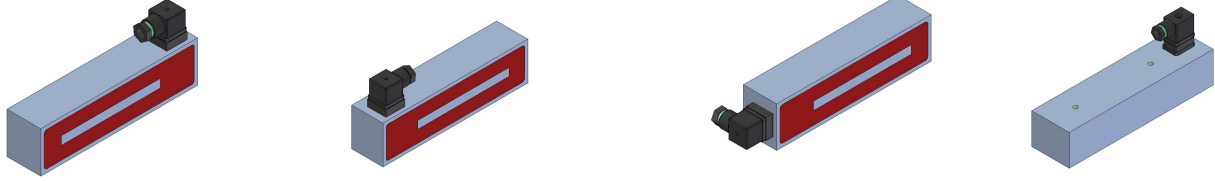

1) Standard mounting 2) Face opposite to standard mounting (Under demand) 3) Longitudinal output (Under demand) 4) Fastening face (Under demand)

Ordering code:

Size; Supply possibilities; Positioning; Voltage; Duty-cycle;

Example: ERM200/35 A2 24Vdc 100% (Connector in the opposite face to standard mounting)
ERM200/60 B4 24Vdc 50% (Stuffing box in the fastening face)

IMPORTANT: Under demand orders can be delayed in the delivery

• VM SERIE

The attraction and holding of magnetic pieces are made by permanent magnets mounted in the electromagnet, with these kind of products we avoid the risk of load falling down due to sudden power supply failure. The power supply on the coil allows to loose the load, when this power supply stops, the product recovers its initial force.

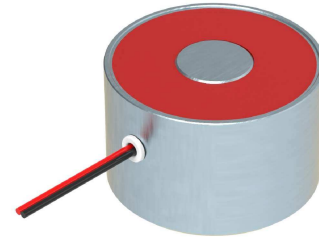

When working with suspended loads, security norms must be respected.

Protection rate: **IP65**
 Insulation class: **B (130°C)**
 Standard voltage: **24VDC**
 Standard duty cycle: **ED100%**
 Different voltage, ED or size: **Consult**

Flying leads for every size
Supply possibilities under demand:
 .With campling screw from the VM25
 .With connector from the VM65.
 The connector (1) has 4 possibilities of direction (4x90°) and it is possible to be incorporated to the same diodes of rectification for alternating current connection (AC).

Table 1

TYPE	øA (-0,3)	B	C±0.1	D	E	F	Weight(Kg)
VM 20	20	M-3	25	5	---	---	0.04
VM 25	25	M-4	27	5	---	40	0.06
VM 30	30	M-4	28	5	---	45	0.17
VM 40	40	M-5	30	6	---	55	0.24
VM 50	50	M-5	35	6	---	65	0.44
VM 65	65	M-8	40	8	112	80	0.74
VM 80	80	M-8	45	8	127	95	1.42
VM 100	100	M-10	50	10	147	115	2.20
VM 150	150	M-16	65	15	197	165	6.60

Flying leads: Ref: VM (type)-V - ED%
 Example: VM 50-24Vdc-ED100%

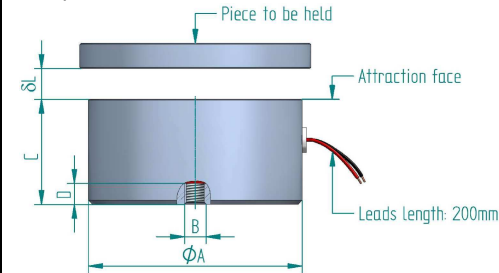

Connector (C): Ref: VM (type)/C-V-ED%
 Example: VM65/C-24Vdc ED100%
 Connection: see documentation that is enclosed with the material

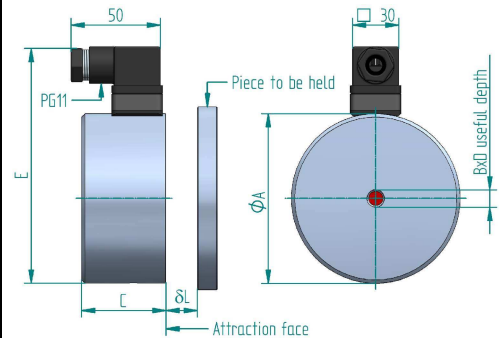

Clamping screw (B): Ref: VM(type)/B-V-ED%
 Example: VM50/B-24Vdc-ED100%

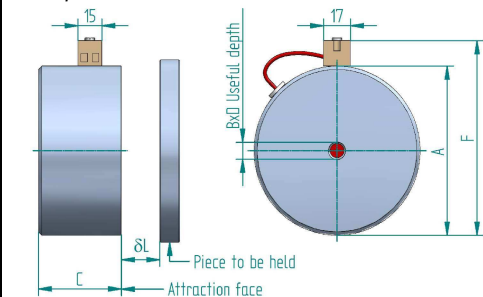

Important: the clamping screw does not have to exceed measure D

Table 2

TYPE	P at 20°C (W)	Thickness of the piece to hold (mm)	Air gap (mm) δL			Magnetic Force Fm (N)
			0	0.1	0.2	
VM20	2.6	1	18	5	1	
		3	18	5	1	
		10	18	5	1	
VM25	4.3	1	20	7	3	
		3	23	7	4	
		10	29	10	7	
VM30	4.5	1	24	10	5	
		3	45	10	6	
		10	52	14	7	
VM40	7	1	39	29	22	
		3	108	57	29	
		10	128	58	37	
VM50	10	1	43	30	28	
		3	129	110	75	
		10	226	125	80	
VM65	14	1	44	35	25	
		3	266	203	140	
		10	374	238	145	
VM80	18	1	44	35	25	
		3	294	267	217	
		10	588	362	256	
VM100	25	1	45	35	25	
		3	299	282	262	
		10	1000	745	519	
VM150	45	1	93	75	60	
		3	415	350	320	
		10	2000	1500	1300	

The table 2 gives for each type of holding magnet, the values of the force of maintenance (Fm) based on the air gap, measured in the following conditions:

- Holding magnet without voltage.
- Flat piece (3µm rugosity) in A°St37, thickness as shown in the table 2 and dimensions are similar or bigger than the attraction face.
- Room temperature 35°C.
- Coil working on its regime temperature.

At different conditions, the magnetic force(Fm) may decrease. The value of the magnetic remanence after the power supply stops is 5% of the holding force.

.Earthing is recommended if the metallic parts are accessible.
 .Technical explanation: see page 4 & 5.

.Under demand: any size, voltage, duty cycle etc can be manufactured.



When lifting or handling heavy loads a minimum security margin of 3 must be respected, the weight of the load cannot exceed 33% of the magnetic force.

• **VM/ND SERIE**

The attraction and holding of the magnetic pieces are made by permanent magnets mounted in the solenoid. With these kind of products, we avoid the risk of load falling due to sudden power supply failure. The power supply on the coil allows to loose the load, when this power supply stops, the product recovers its initial force.

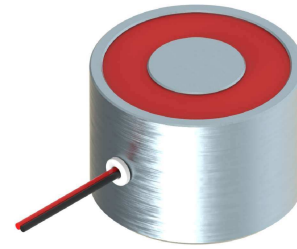

When working with suspended loads, security norms must be respected.

Protection rate: **IP65**
 Insulation class: **Y (90°C)**
 Standard voltage: **24VDC**
 Standard duty cycle: **See chart**
 Different voltage, ED or size: **Consult**

Supply possibilities:
 Flying leads for every size:
 VM20/ND, VM30/ND, VM40/ND: 1x0.25mm²
 VM50/ND, VM65/ND, VM100/ND: 1x0.5mm²
 VM150/ND: 2x0.75mm²
 Under demand: any size, voltage, duty cycle etc can be manufactured

Table 1

TYPE	øA (-0,3)	B	C(±0,1)	D	E	Weight(Kg)
VM 20/ND	20	M-3	25	5	26	0.04
VM 30/ND	30	M-4	32.5	6	35.2	0.13
VM 40/ND	40	M-5	41.7	6	42.7	0.28
VM 50/ND	50	M-5	42.8	6	52.5	0.45
VM 65/ND	65	M-8	45.5	8	67	0.74
VM 100/ND	100	M-10	67	10	102	3.00
VM 150/ND	150	M-16	65	15	152	7.10

Flying leads

Feeding mode to take off the workpiece:
 Voltage: 24Vdc
 Polarization:
 Red lead +VDC / Black lead -VDC

Important: the clamping screw does not have to exceed measure D

TYPE	P (W)	ED (%)	Minimum pulse (ms)	Resting time (ms)	e (mm)	Air gap (mm) ΔL			Magnetic force Fm (N)
						0	0.2	0.5	
VM20/ND	10	20	24	180	1	22	7	1.7	
					3	39	7	1.7	
					10	39	7	1.7	
VM30/ND	25	20	110	825	1	46	34	22	
					3	181	74	22	
					10	181	74	22	
VM40/ND	42	15	75	743	1	51	36	23	
					3	205	89	38	
					10	270	89	38	
VM50/ND	48	15	120	1188	1	60	41	34	
					3	304	200	95	
					10	607	225	110	
VM65/ND	80	15	225	2228	1	70	50	40	
					3	374	340	260	
					10	1220	750	400	
VM100/ND	75	25	150	1500	1	83	61	49	
					3	421	365	338	
					10	2205	1254	686	
VM150/ND	77	40	285	1070	1	78	46	32	
					3	615	475	401	
					10	2254	1490	1100	

e (mm): Thickness of the piece to hold

The table 2 gives for each type of holding magnet, the values of the minimum pulse time and resting time measured in the following conditions:
 - With a weight of 5% of the maximum magnetic force made by each model
 -Coil working on its regime temperature.
 The table 2 gives for each type of holding magnet, the values of the force of maintenance (Fm) based on the air gap, measured in the following conditions:
 -Holding magnet without voltage.
 -Flat piece (3µm rugosity) in A⁰St37, thickness as shown in the table 2 and dimensions are similar or bigger than the attraction face.
 -Room temperature 35°C.
 -Coil working on its regime temperature.
 At different conditions, the magnetic force(Fm) may decrease.
 The value of the magnetic remanence after the power supply stops is 5% of the holding force.
 .Earthing is recommended if the metallic parts are accessible.
 .Technical explanation: see pages 4 & 5.
 .Under demand: any size, voltage, duty cycle etc can be manufactured.

Under demand an internal protection can be added to the coil to protect it of the overheating, generated by the no respecting of the times given by the duty cycles, this overheating can demagnetize the internal magnet or destroy the coil changing the proper working of holding magnet.

⚠ When lifting or handling heavy loads a minimum security margin of 3 must be respected, the weight of the load cannot exceed 33% of the magnetic force.

Ordering code : VM(size)/ND --V ED---%
 VM50/ND; Voltage : 24Vdc ; Duty cycle : ED15% ; Ref.: VM50/ND 24Vdc ED15%
 VM50/ND with protection ; Voltage : 24Vdc ; Duty cycle : ED15% ; Ref.: VM50/ND_WP 24Vdc ED15%

• ERMI 200-60 TYPE

The attraction and holding of the magnetic pieces are made by permanent magnets mounted in the solenoid. With these kind of products, we avoid the risk of load falling due to sudden power supply failure. The power supply on the coil allows to loose the load, when this power supply stops, the product recovers its initial force. When working with suspended loads, security norms must be respected.

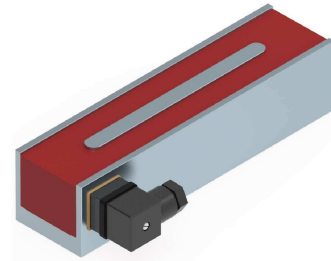

Protection rate: **IP65**
 Insulation class: **Y (90°C)**
 Standard voltage: **24VDC**
 Standard power: **250W**
 Standard duty-cycle: **ED15%**
 Solenoid weight: **4.7 kg**

Supply possibilities:

- Connector standard
- **Alternating current connection (AC):**
 The connector offers the possibility of incorporating rectifying diodes
- Under demand: other possibilities of input can be manufactured.

If any changes from the original (see drawing), please contact.

- Electric connection of the connector:
 see documentation that is enclosed with the material
- Earthing is recommended if the metallic parts are accessible.
- Technical explanations: see pages 4 & 5.

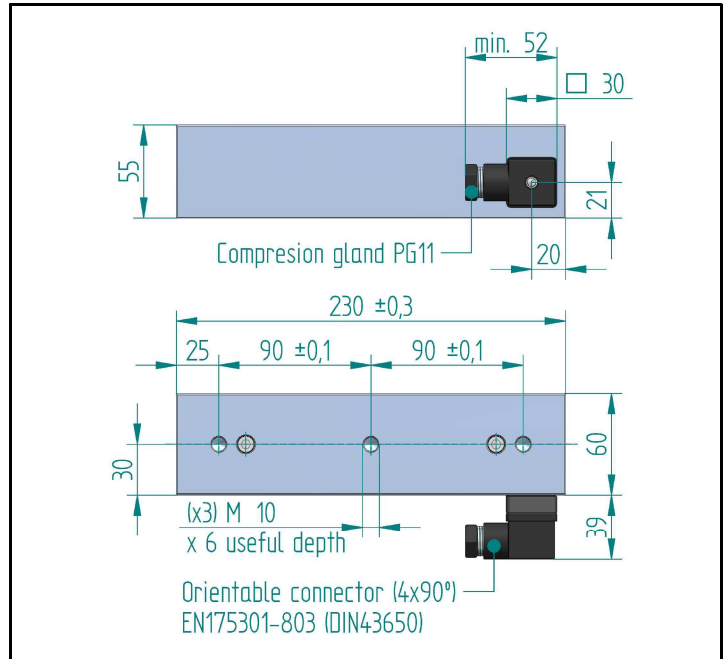

Table 1

Thickness of the piece to hold (mm)	Air gap (mm) δL							Magnetic Force Fm (N)
	0	0.1	0.2	0.3	0.4	0.5	1	
1	250	210	190	180	165	160	140	
3	1350	1250	1150	1100	1000	925	570	
6	2350	2000	1750	1400	1200	1100	590	
10	2800	2450	2150	1900	1600	1400	700	
18	3000	2550	2300	2000	1700	1500	800	

For these holding electromagnet correct working the minimum pulse and resting time must be respected:

- **Minimum pulse time: 300ms**
- **Minimum resting time: 5000ms**

The values of the minimum pulse time and resting time measured in the following conditions:

- Coil working on its regime temperature.
- Piece weight: 2 Kg (it is not recommended to use these holding electromagnet for lower weights)

The table 2 gives for each type of holding magnet, the values of the force of maintenance (Fm) based on the air gap, measured in the following conditions:

- Holding electromagnet without voltage.
- Flat piece ($3\mu\text{m}$ rugosity) in A°St37, thickness as shown in the table 2 and dimensions are similar or bigger than the attraction face.
- Room temperature 35°C.
- Coil working on its regime temperature.

At different conditions, the magnetic force(Fm) may decrease. The value of the magnetic remanence after the power supply stops is 5% of the holding force.



When lifting or handling heavy loads a minimum security margin of 3 must be respected, the weight of the load cannot exceed 33% of the magnetic force.

Ordering code:

Ref.: *ERMI200/60 24Vdc ED15%*

● BP 1000-10 TYPE

It is a bipolar holding electromagnet with 1000mm of effective surface. The face is made with an angle to work with different pieces between $\varnothing 120\text{mm}$ y $\varnothing 250\text{mm}$.

The attraction and holding of the magnetic pieces is obtained by feeding the coil inside the electromagnet. When the power supply stops the electromagnet looses the piece. When working with loads security norms must be respected.

Protection rate: **IP65**
 Insulation class: **B (130°C)**
 Standard voltage: **24Vdc**
 Standard duty cycle ED: **100%**
 Abs. power at 20°C: **217W**
 Temperature rise "DV31" **40°C**
 Solenoid weight: **47Kg**

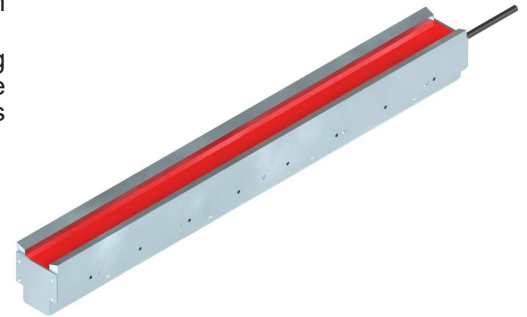

● Maximum keeping force

\varnothing Round bar (mm)	Force N/mm	Force N (for bar => 1000mm)
$\varnothing 120\text{-}\varnothing 200$	5.4	5400
$\varnothing 250$	8	8000

The forces values are obtained with the electromagnet at its working temperature and with the piece to be held in contact with whole attraction surface

1) To feed in alternating current the electromagnet will have an external rectifier.

2) It can be manufactured at any voltage, duty cycle, connection etc. Also other sizes for different applications.

3) Ground connection is recommended if to the metallic parts are accessible.

● General dimensions

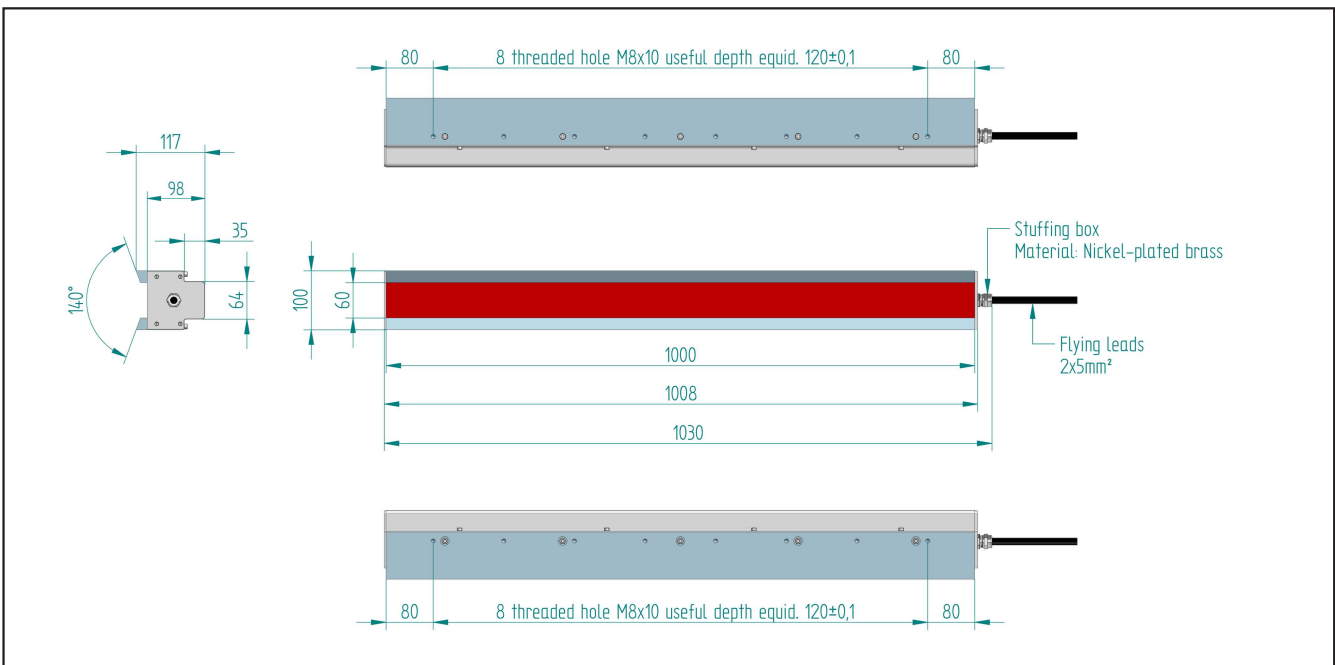

When lifting or handling heavy loads a minimum security margin of 3 must be respected, the weight of the load cannot exceed 33% of the magnetic force.

Ordering code: BP1000/100 --V ED---%

Voltage: 24Vdc; Duty-cycle: ED100%
 BP1000/100 24Vdc ED100%